

What's New in Autodesk Inventor 2020

This year we celebrate Inventor's 20-year anniversary with the release of Inventor 2020. This release delivers a host of enhancements to help you solve complex product design challenges and get more done in less time.

Access the Inventor 2020 release from your [Autodesk Account](#).

Inventor 2020 delivers:

- **Enhanced User Interface (UI) and Workflows:** Streamlined part modeling, smart sketch profile detection, multi-monitor app frame, and a modernized look and feel.
- **Customer Driven Improvements:** Solid sweep, frame design productivity, complex surface unwrap and flattening, read-only mode, settings presets, and several more from [Inventor Ideas](#) that came directly from you.
- **Continued Delivery of Professional Grade Functionality:** Faster import, patterning, navigation, Tube & Pipe route edits, as well as expanded Express Mode functionality.
- **Multiple Fixes Improving Stability and Quality:** [Click here](#) for a detailed list of these improvements.

Read below for more details on what's new.

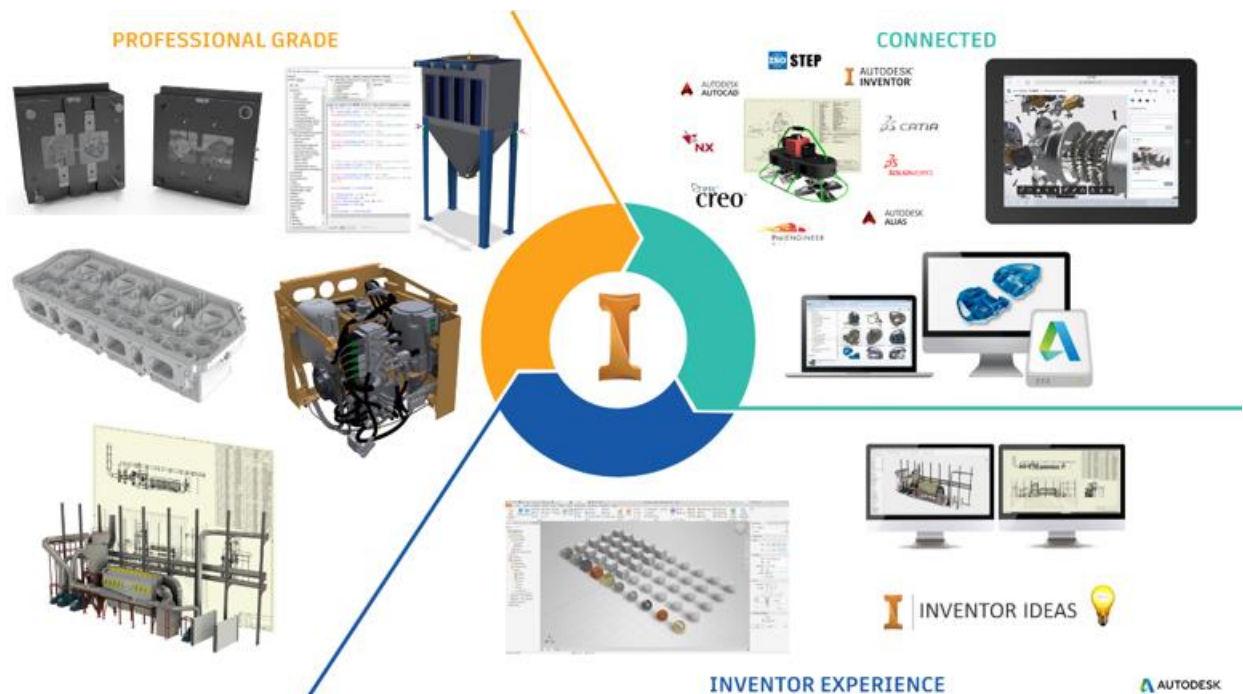

Inventor Experience

UI Enhancements

Inventor 2020 delivers a fresh new Light Theme interface that enhances functionality and improves productivity. The Light Theme includes an overall visual refresh for lighting styles, icon refresh throughout Inventor, graphic presets for changing multiple model view settings, multi-monitor support, and extended migration enhancements for moving from past versions to Inventor 2020.

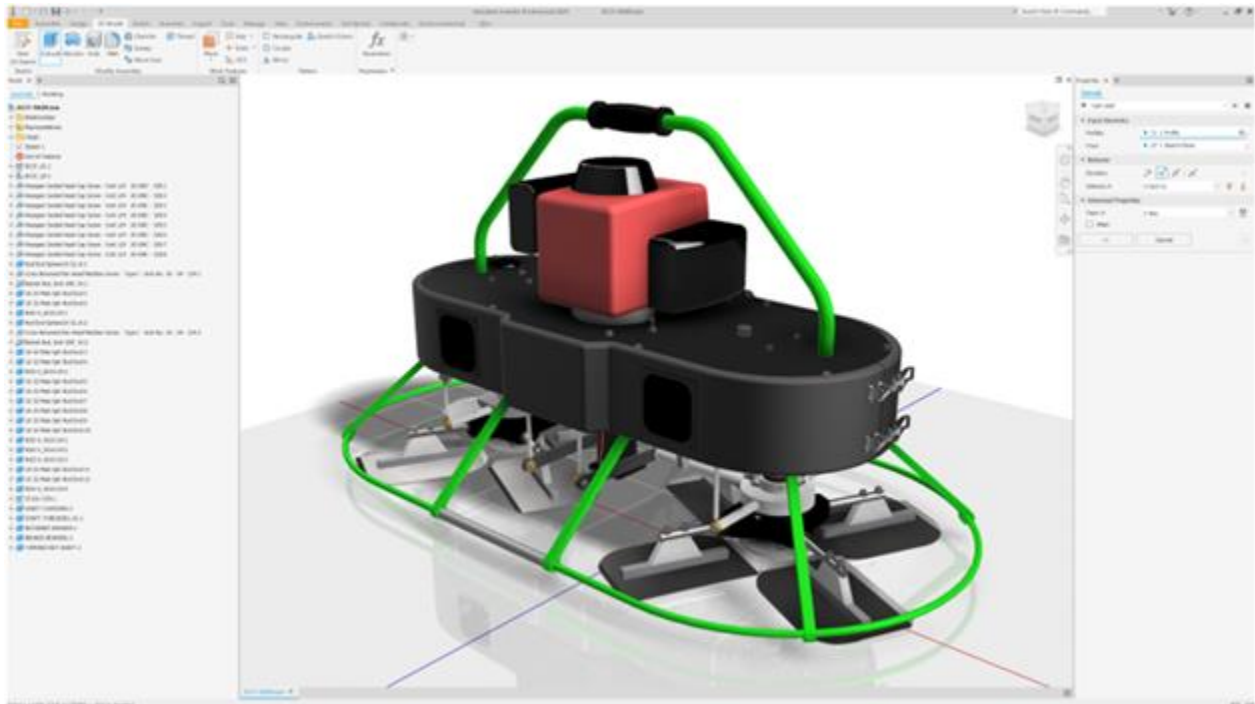

Command UI and Productivity Enhancements

Starting with the Measure command in Inventor 2018, and the Hole command in Inventor 2019, additional commands are refreshed with a new property panel UI that includes functionality and workflow improvements. Inventor 2020 extends the property panel UI to the Extrude, Revolve, Sweep and Thread commands to enhance functionality and increase productivity.

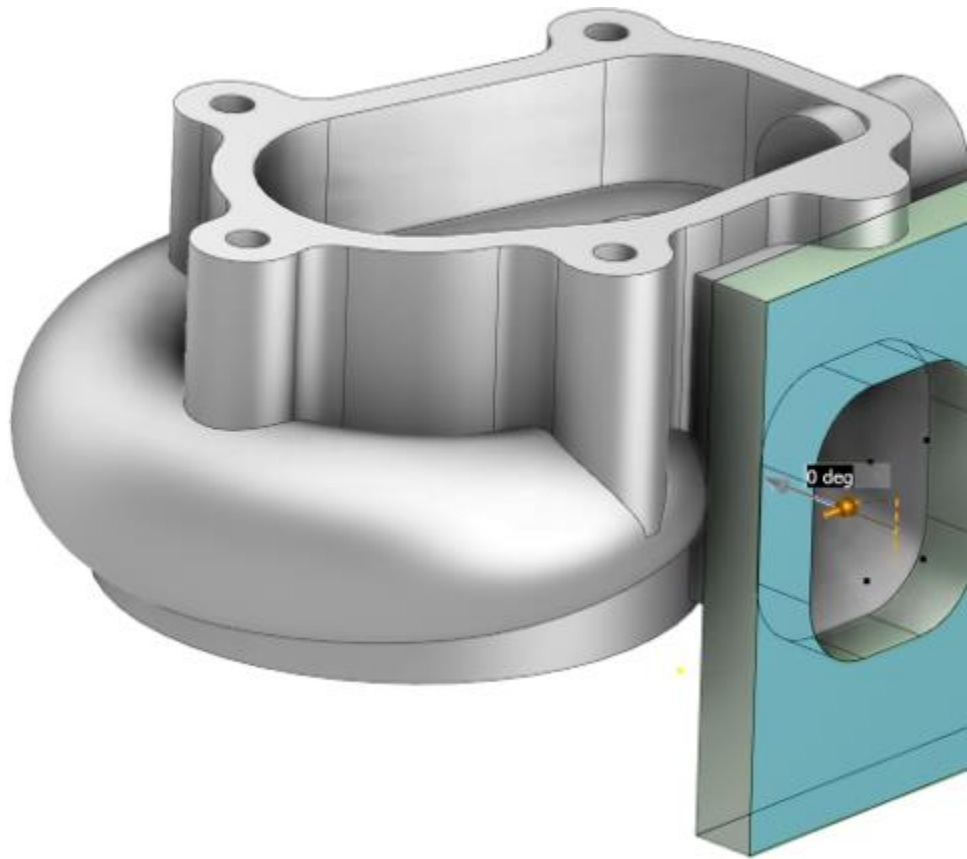
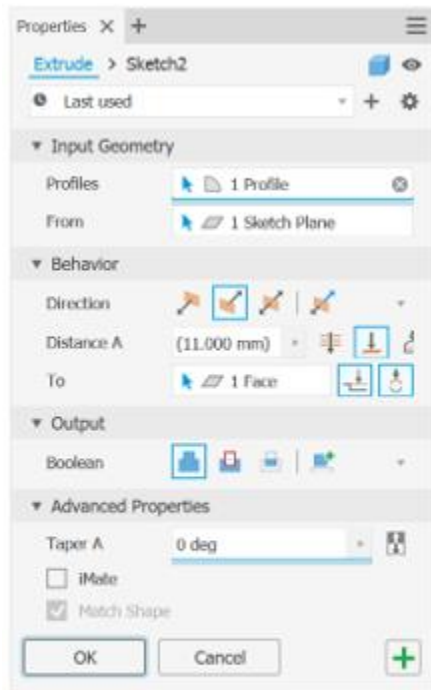

Professional Grade Design and Engineering

Performance Improvements

Inventor customers are constantly pushing the software with larger and more complex designs. To help our customers, we are continually looking for ways to improve Inventor performance. In Inventor 2020, you'll experience improved performance with assembly, part, drawing, and AnyCAD workflows.

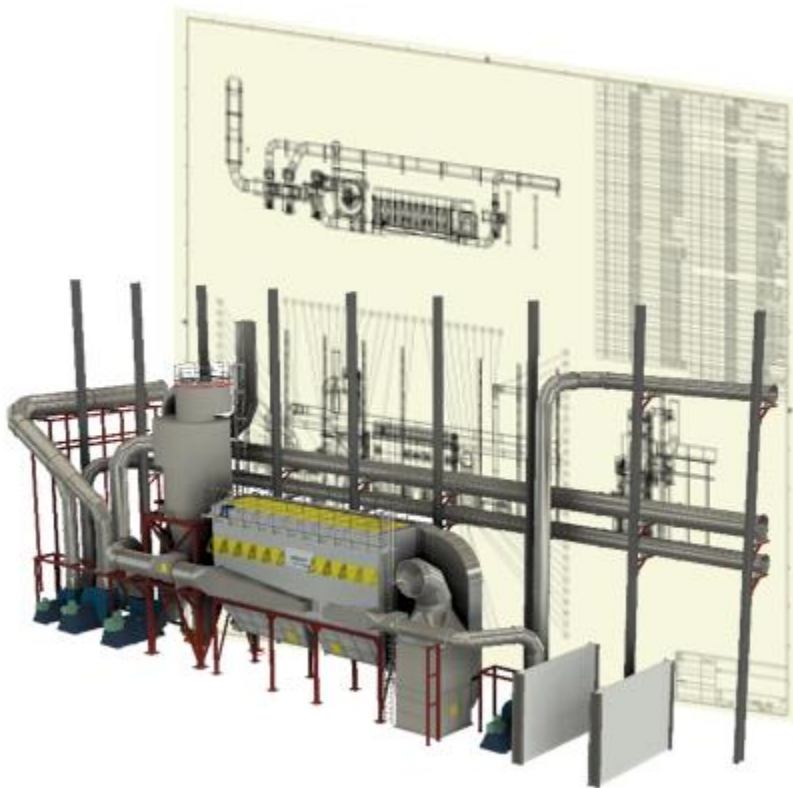

Design Enhancements

Inventor 2020 continues to deliver new functionality to core design commands and workflows. Enhancements are made to sketching and Content Center to improve overall productivity.

Sweep is improved by adding Solid Sweep functionality for removing and adding swept geometry by sweeping a 3D tool body.

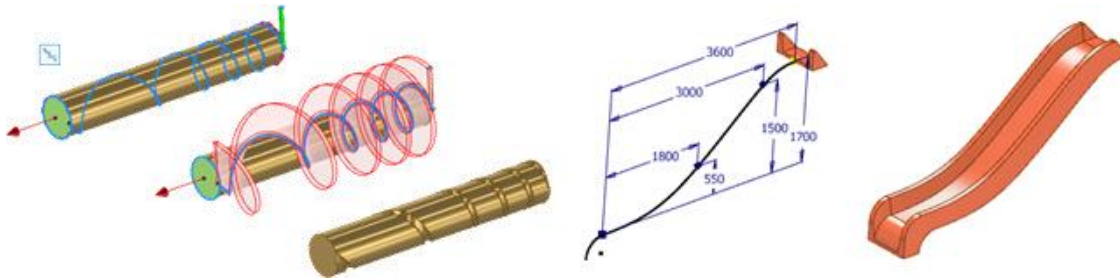

I [An Inventor® Ideas submission](#)

The new Unwrap command is introduced to allow you to get a flat surface from any set of continuous faces. Unwrap lets you flatten nearly any shape into a surface that can be saved or exported in different formats.

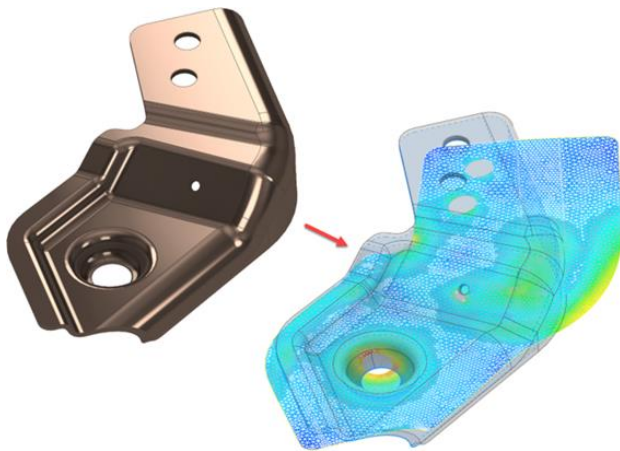

I [An Inventor® Ideas submission](#)

Significant improvements are made to Frame Generator. Many of the Frame Generator commands now use the property panel UI.

Install the Custom Content library to use the new End Cap command added with Inventor 2020. Notch and Insert Frame functionality are improved.

I [An Inventor® Ideas submission](#)

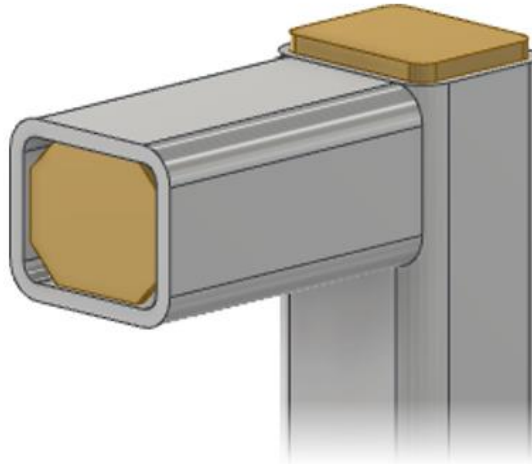
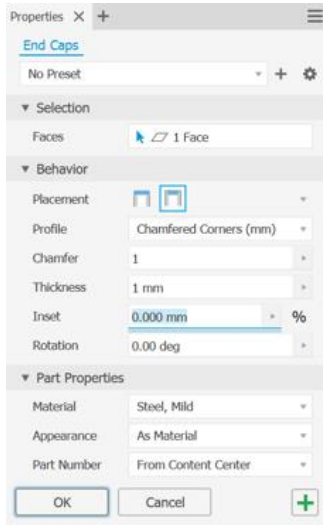

Translation and Interoperability

AnyCAD for Fusion 360, which was released in 2018.2 as a Tech Preview, is now fully released as a feature for Inventor and Fusion 360 subscribers. AnyCAD for Fusion 360 is for customers who need to share data between Fusion 360 and Inventor for collaboration, , electro-mechanical, and other workflows.



Many of the 3rd party supported versions are updated for file translation with Inventor 2020.

Customer Driven Improvements

The Inventor community continues to provide feedback and requests through [Inventor Ideas](#) and [Feedback Community](#).

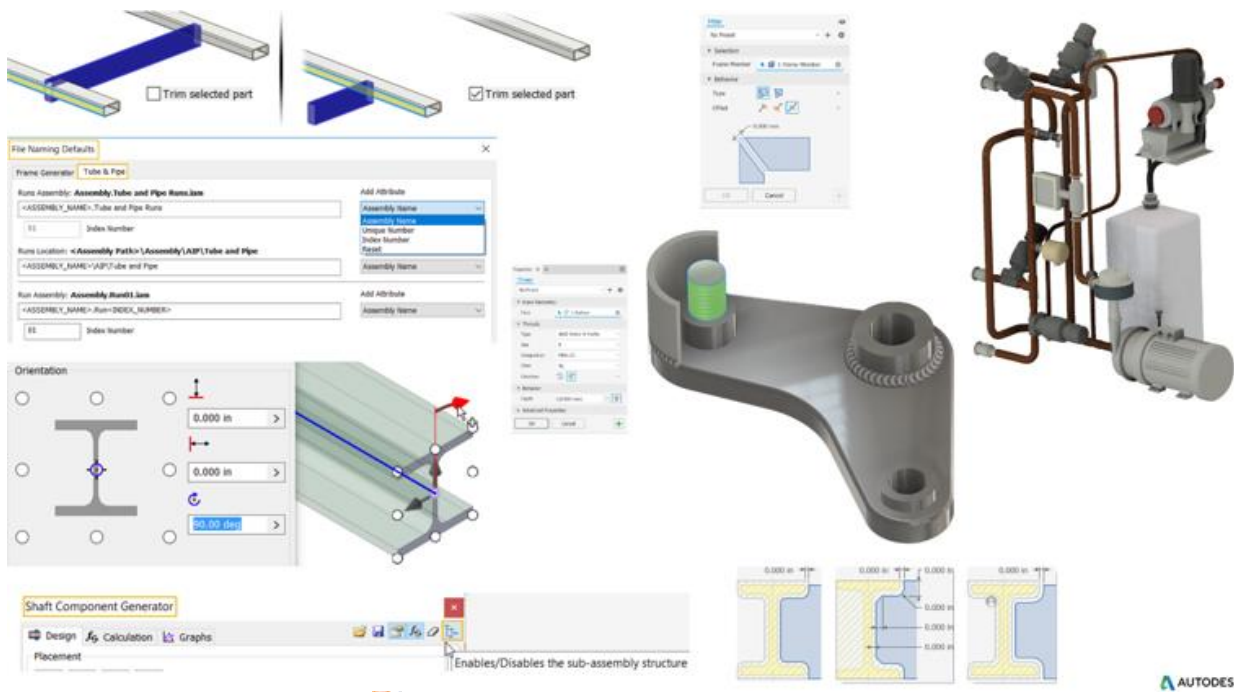

Improvements labeled with **I** **An Inventor® Ideas submission** in the What's New indicate new functionality delivered as a direct result of your requests. The customer driven improvements in Inventor 2020 include the Ideas indicated above, as well as:

The sheet metal style of the source component can now be included with the Mirror Component for sheet metal parts.

I [An Inventor® Ideas submission](#)

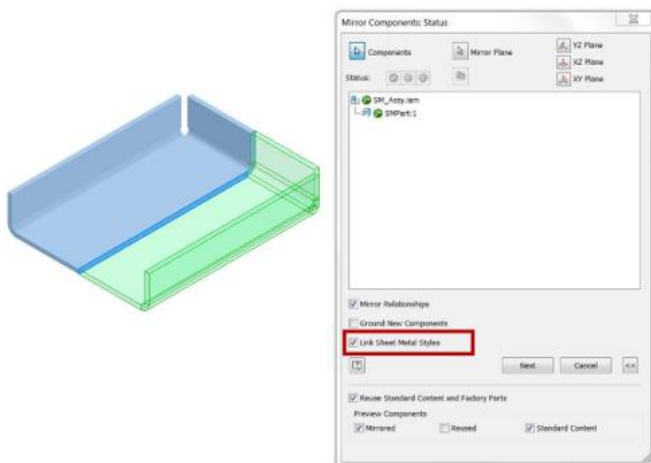

Joints can now be added to Slot geometry.

[An Inventor® Ideas submission](#)

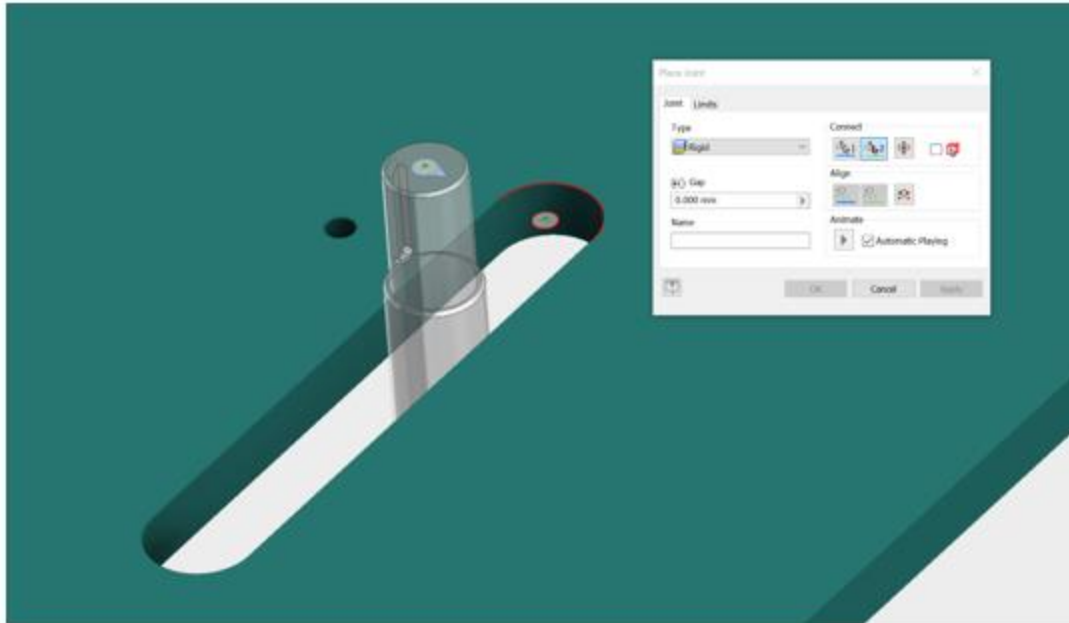

Sketch blocks consumed by features are now reported in the Relationships dialog box in parts.

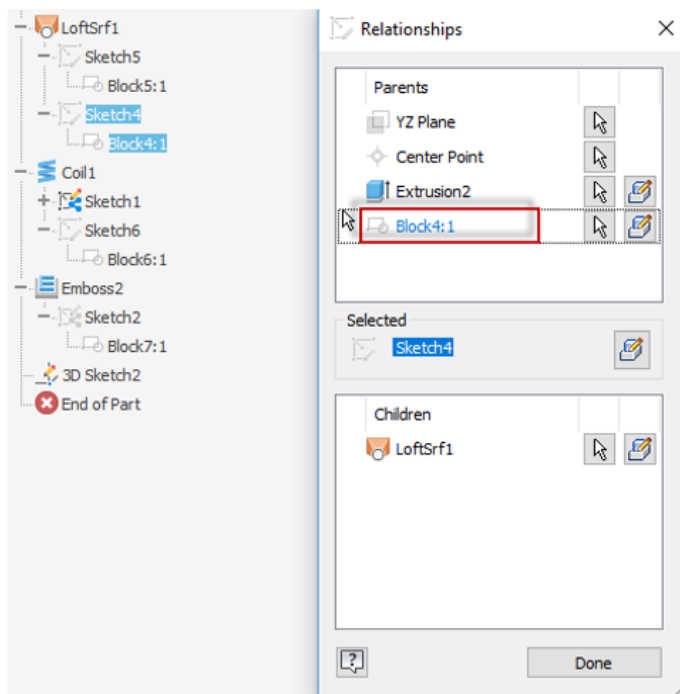

Inventor 2020 can now be launched in Inventor Read-only Mode to view native Inventor files. Inventor Read-only mode does not require licensing.

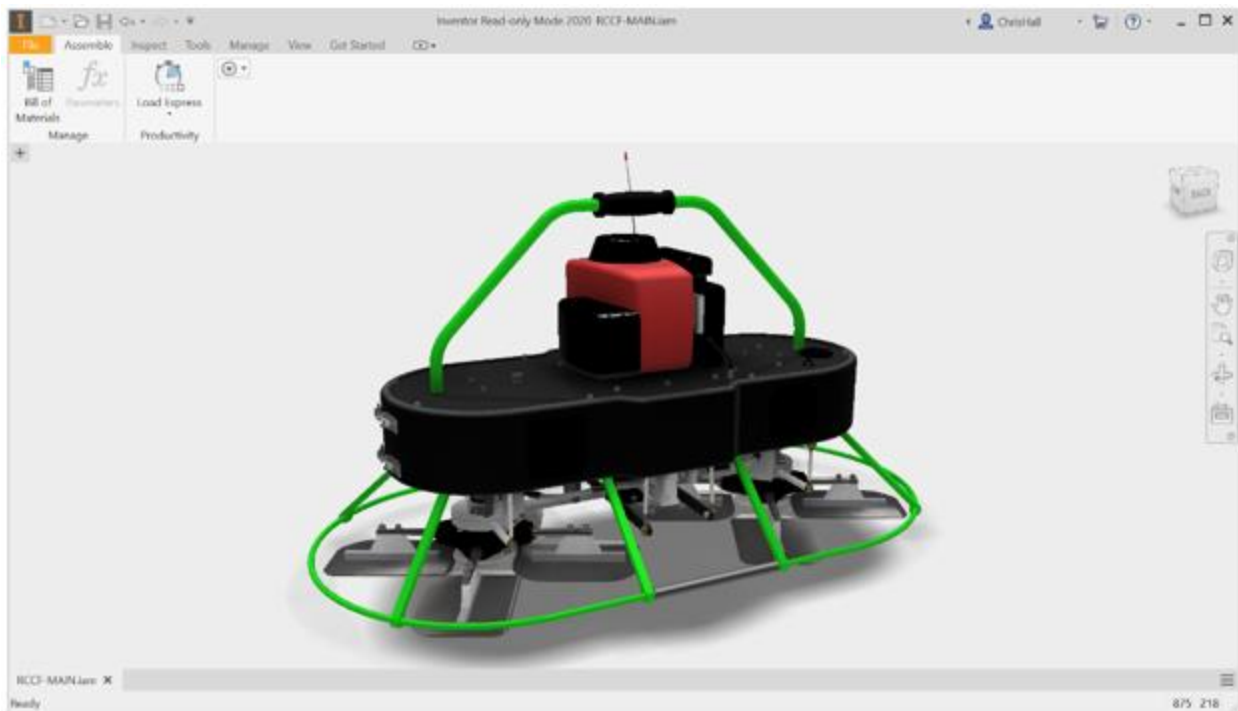

Your feedback is very important to the Inventor team. We value your feedback and product improvement requests. Please join the following communities to provide your feedback to the Inventor team.

[Feedback Community](#)

[Inventor Ideas](#)

[Inventor Forums](#)

Installation

AutoCAD Mechanical drawing templates are no longer included in an Inventor installation. Download AutoCAD Mechanical template files, from [Inventor 2020 Language Packs](#).

What's New for Inventor Workflows Accessible for Product Design and Manufacturing Collection Subscribers

[Inventor NASTRAN](#)

[Inventor Nesting](#)

[Inventor CAM](#)

[Inventor Tolerance Analysis](#)

[Factory Design Utilities](#)

General Enhancements in Assembly

Assembly Constraints

When placing a mate constraint between 2 axes, Inventor now predicts the best match based on the selection with minimal rotation. Inventor assigns the optimal selection before displaying the preview.

For example, if you select axis 1 with a direction and then select axis 2, the relative position with minimum rotation is maintained. Also, the type of direction (opposed or aligned) is specified. This behavior allows you to add a manual control to prevent the components from orienting incorrectly.

Note: The values specified in the assembly Place Constraint dialog box no longer persist within the same session.

Express Mode

Important: Skeletal modeling workflows are available in Express Mode.

The following commands are now available in Express mode:

- Drive Constraint
- Create and edit 2D sketches
- Work feature selection and visibility controls
- Visibility for Shared and unconsumed sketches
- Selection Priority: Select Sketch Features

Assembly Sketch

The Ellipse command is moved to the Circle group in the Create panel to provide consistent access in both Part and Assembly environments.

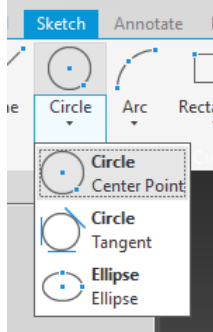

Productivity Tools

In the Create Derived Substitutes dialog box, you can remove a row by right-clicking the row, not just the left most cell.

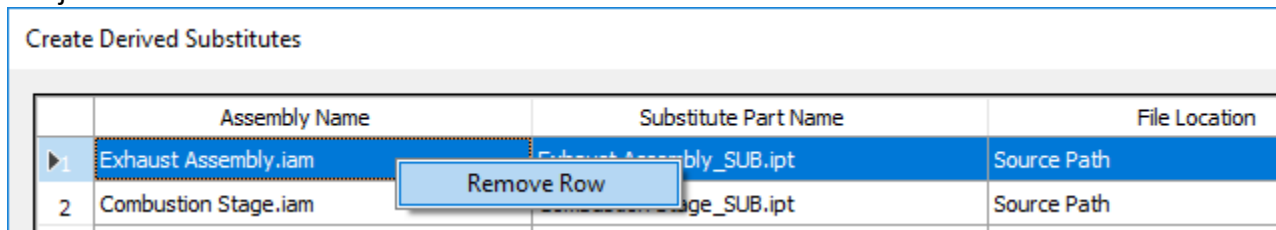

Tube & Pipe

The Application Options, File tab, File Naming Defaults dialog box now includes a Tube & Pipe tab where you can specify how Tube & Pipe creates files and folders. For example, you can use these settings to keep the folder structure flat and completely eliminate the AIP sub-directory. In addition, you can now configure the naming scheme using the options in the new Add Attribute drop-list.

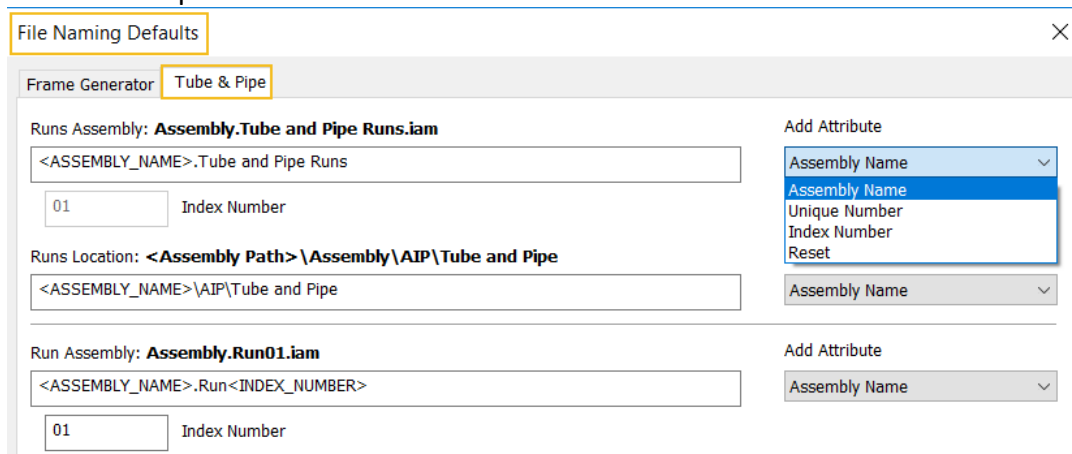

 [An Inventor® Ideas submission](#)

Design Accelerator/Shaft Generator

The Shaft Component Generator dialog box now includes a toggle that allows you specify how files and folders for Shaft components are created.

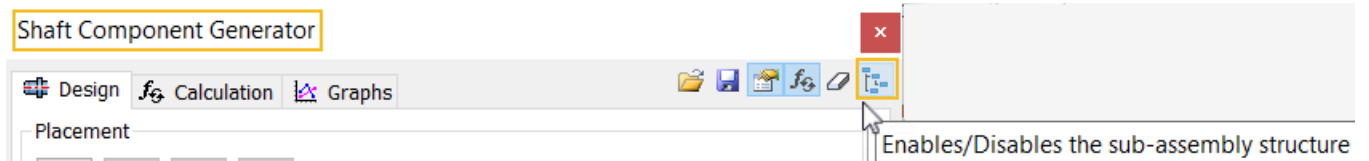

By default, the toggle  disables the creation of a sub-assembly structure and creates a single part within your root assembly.

File Naming

Item	Display name	File name
Shaft	Shaft	C:\Users\waykerj\Documents\Tutorials\Bolted Connection\Shaft1.ipt

When toggled off, , the creation of a sub-assembly structure is enabled.

File Naming

Item	Display name	File name
Subassembly	Shaft	C:\Users\waykerj\Documents\Tutorials\Bolted Connection\Bolted_connection\Design Accelerator\Shaft1.iam
Shaft	Shaft	C:\Users\waykerj\Documents\Tutorials\Bolted Connection\Bolted_connection\Design Accelerator\Shaft1.ipt

Joint Creation Enhancement

You can now select the center point of a slot to define a joint.

 [An Inventor® Ideas submission](#)

Mirror Components/Sheet Metal Enhancement

The Mirror component command now recognizes a sheet metal part and lets you link the sheet metal style of the source component to the mirrored copy.

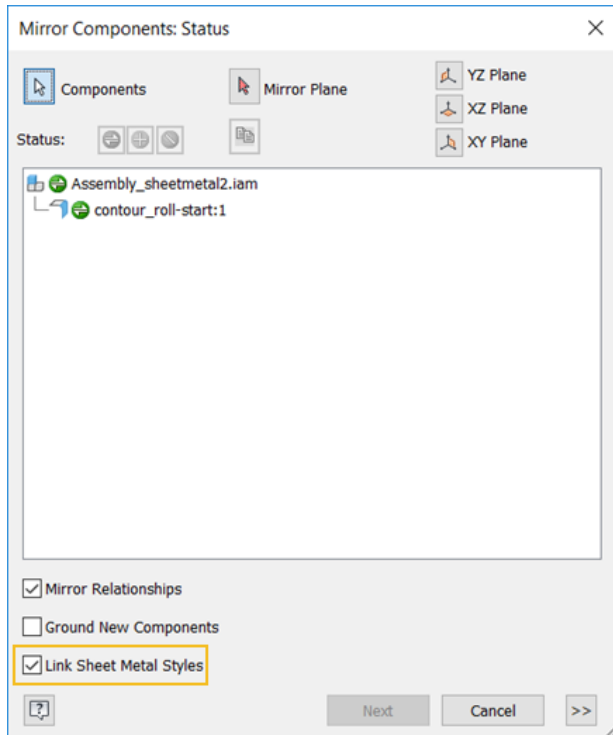

 [An Inventor® Ideas submission](#)

Support for Threads in Assemblies

You can now create thread features in assemblies.

Access:

Assembly: 3D Model tab, Modify Assembly panel, Thread 

Weldment assembly: Weld tab, Preparation and Machining panel, Thread 

 [An Inventor® Ideas submission](#)

Frame Generator Enhancements

Insert End Cap

Be sure to install the Custom Content library to access the new End Cap members.

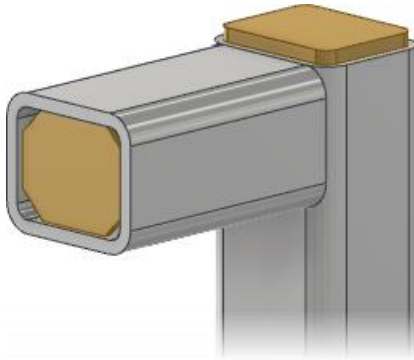

Use the new Insert End Cap command to close structural frame members. You can set the position, thickness, specify the profile shape, other properties.

Tip: Save the Inventor end cap families to your own library to customize the end caps. For example, to place a drain hole in the profile.

[An Inventor® Ideas submission](#)

An End Cap entry was added to the Frame Generator File Naming Default options.

End Cap: **Plate Fillet Corners (in) 19283746.ipt**

Plate <FAMILY_NAME> <UNIQUE_NUMBER>

000001

Index Number

Add Attribute

Assembly Name

[An Inventor® Ideas submission](#)

Notch

The Notch command is now a property panel. In the new panel, you do not need to select an option to notch multiple members at the same time.

Previously, it was difficult to create a custom notch. In this release, you can now specify the following:

Basic Profile to set a single offset value.

Custom I Template to set multiple offset values.

Custom Profile, if available, to use a custom notch profile saved in the Content Center family.

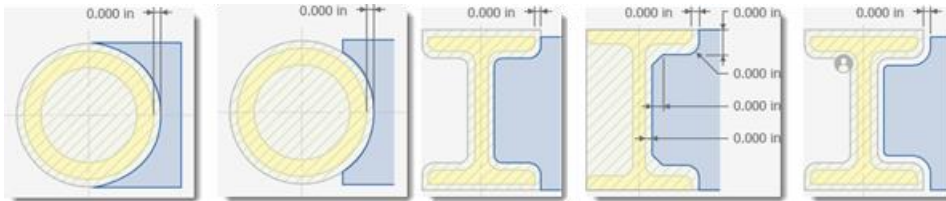

Check the new Perpendicular Cut option to create precise intersections.

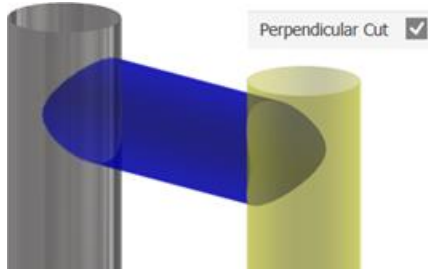

In-canvas Orientation Tools

You can now interact with in-canvas manipulators when you insert or change a frame member.

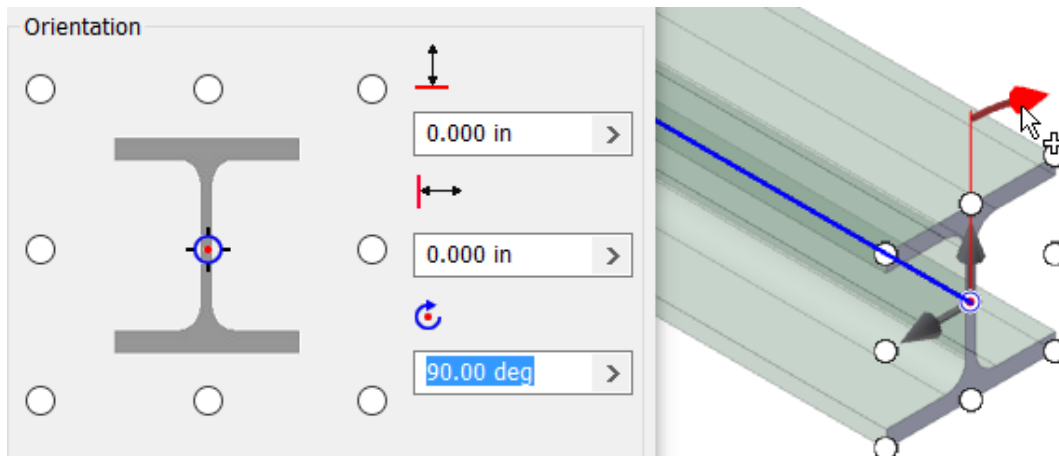

Lengthen/Shorten

In addition to the new property panel, the Lengthen/Shorten command now allows you to specify asymmetric offset values.

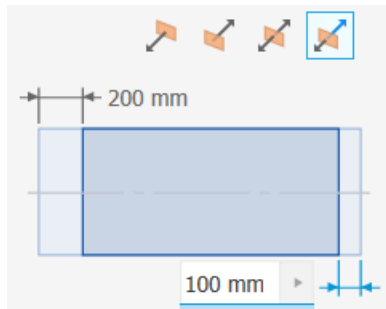

Miter

The Miter command is now a property panel. In the new panel, you do not need to select an option to miter multiple members at the same time.

Trim/Extend to Face

A Trim selected part checkbox is added that lets you select the side you want to keep.

The following image shows the effect of using the new option.

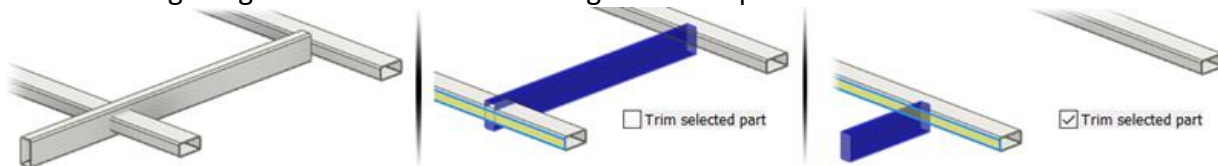

Remove End Treatments

You can now remove end treatments from multiple members at the same time.

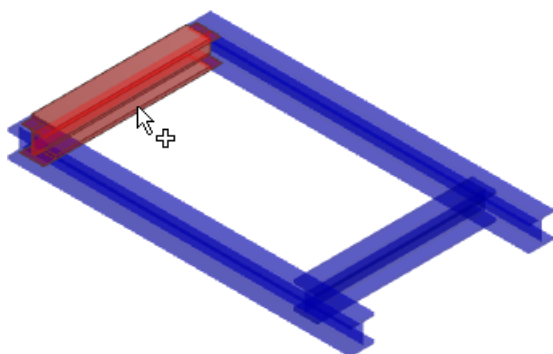

Feature Productivity, Workflow, and UI Enhancements

The number of property panel based commands is increasing. As they are added, information about property panels and some of their controls is updated

The following commands now make use of property panels:

Extrude

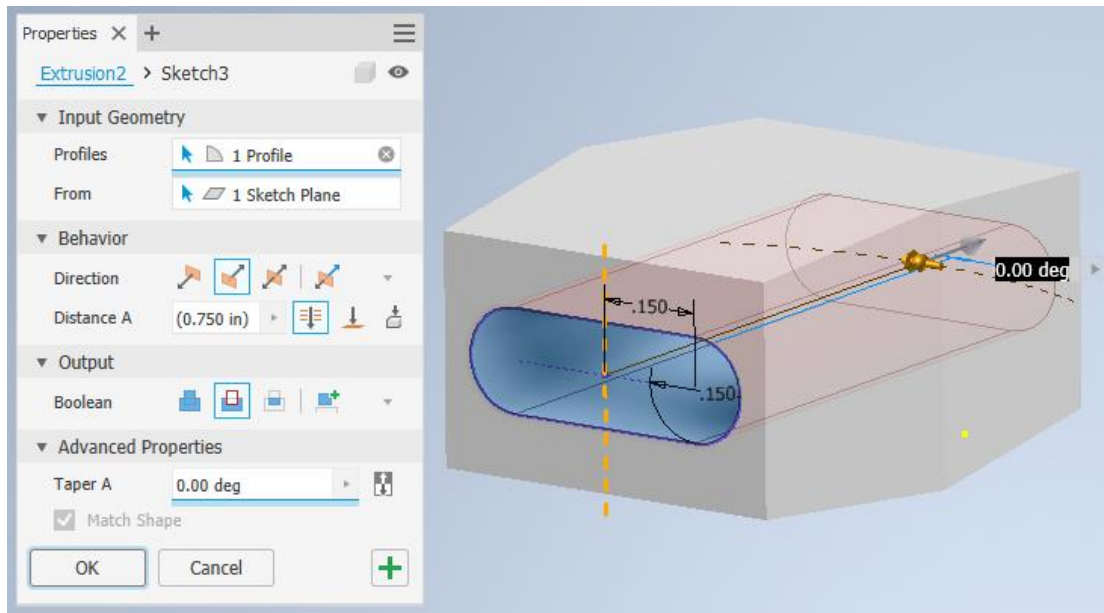

When using the taper option with adjacent regions, the operation merges the faces to create a single, unified result.

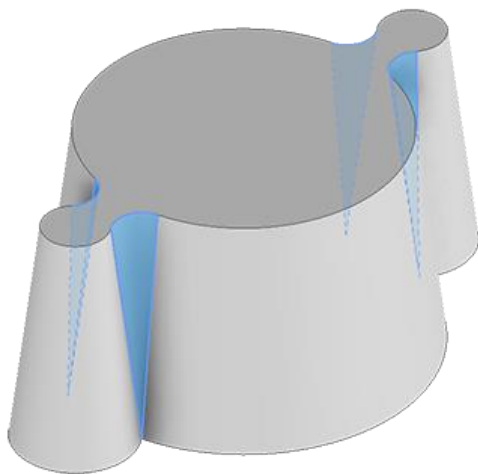

Revolve

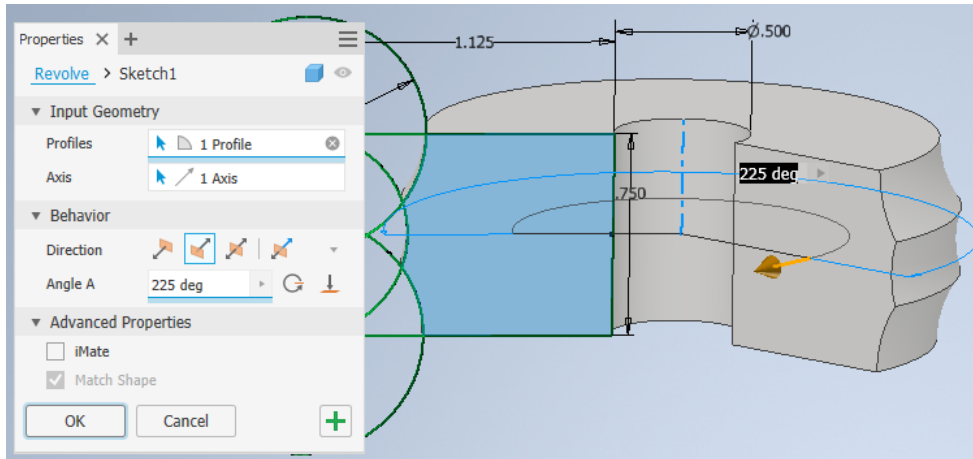

Sweep

In addition to the property panel, the Sweep command now supports sweeping a solid.

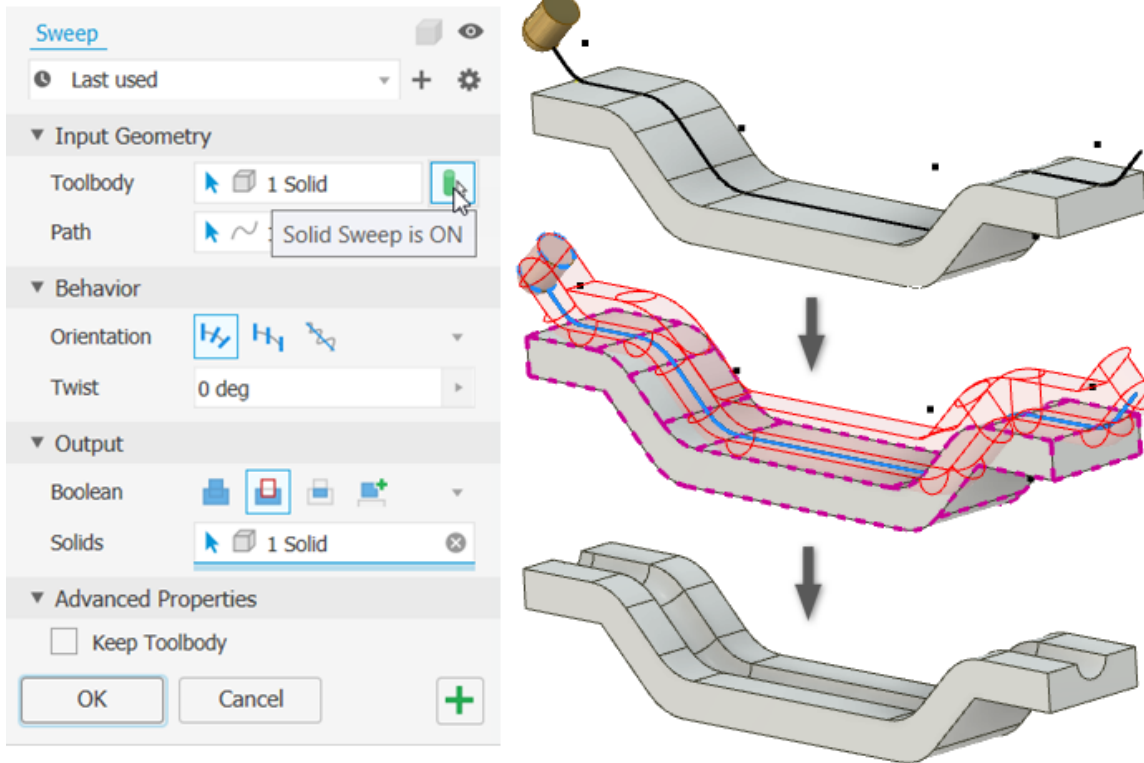

Loop and Region Detection

Identifying and selecting loops and regions is significantly enhanced. As you hover or move the cursor over sketch loops or enclosed regions they highlight. This behavior applies to sketch blocks as well. As in previous releases, use Ctrl+click to add or remove items from the selection set. The cursor and status bar notification update to show the action that will happen as you hover over loops or regions.

Hidden Lines in Selections

Recent performance improvements altered the way hidden lines displayed for selected bodies. To restore legacy hidden line display for selected objects in Full Mode you need to add the environment variable: DRAW_HIDDENEDGE_SELECTION

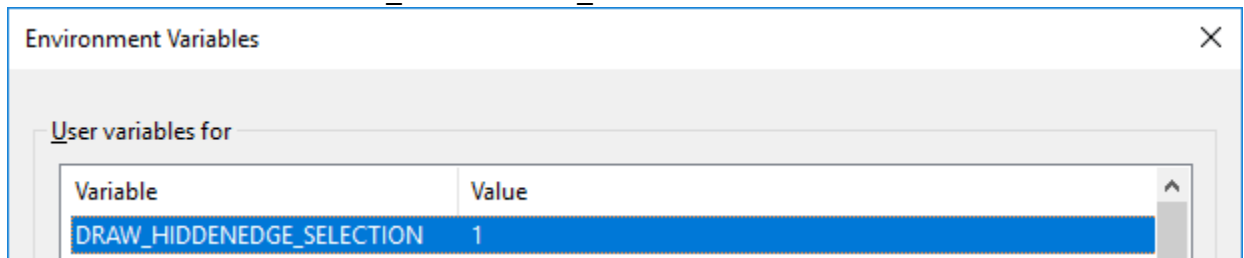

The Value must be set to a non-zero value.

Part Enhancements

Unwrap Contiguous Faces

I [An Inventor® Ideas submission](#)

I [An Inventor® Ideas submission](#)

The new Unwrap command can flatten faces that cannot be calculated with the Unfold or sheet metal flat pattern commands. For example, to determine a fabric pattern or for flattening stamped objects. Unwrap does not use bend calculations to flatten the selected faces.

A heat map is displayed during the Unwrap process so you can see areas of highest to least tension. You can specify contiguous segments to remain linear or rigid.

The option Create Dedicated View Representation makes it easy to isolate and document the output surface.

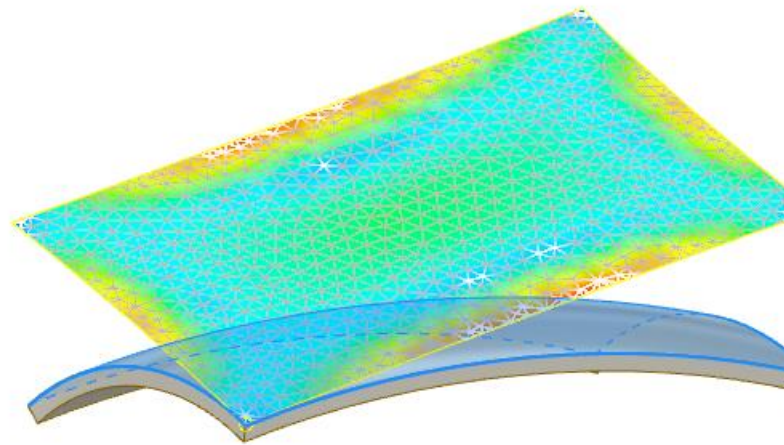
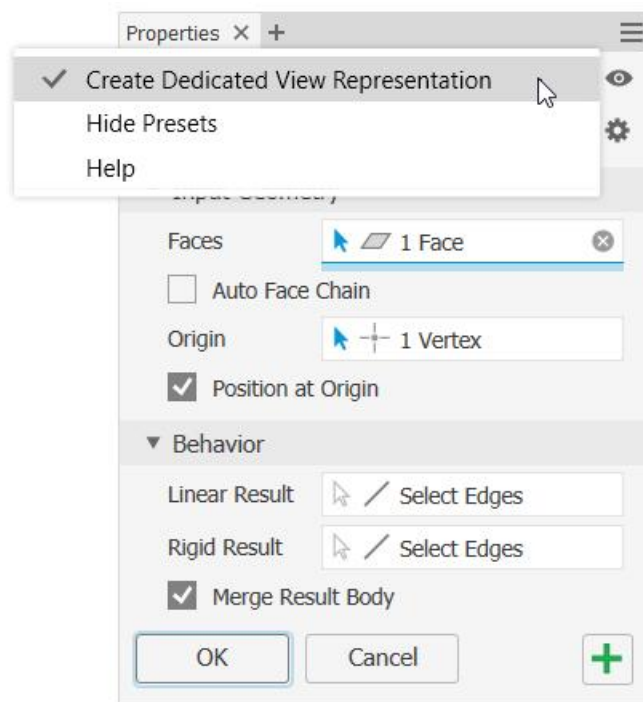

Tip: Suppress the embossed features on a sheet metal part to calculate the flat pattern and then unsuppress and selectively unwrap the embossed areas.

Solid Sweep

I [An Inventor® Ideas submission](#)

In addition to a new property panel for a streamlined workflow, Solid Sweep enables sweeping a solid toolbody along a path. The following example shows a Fixed sweep path with no twist to simulate a toolpath.

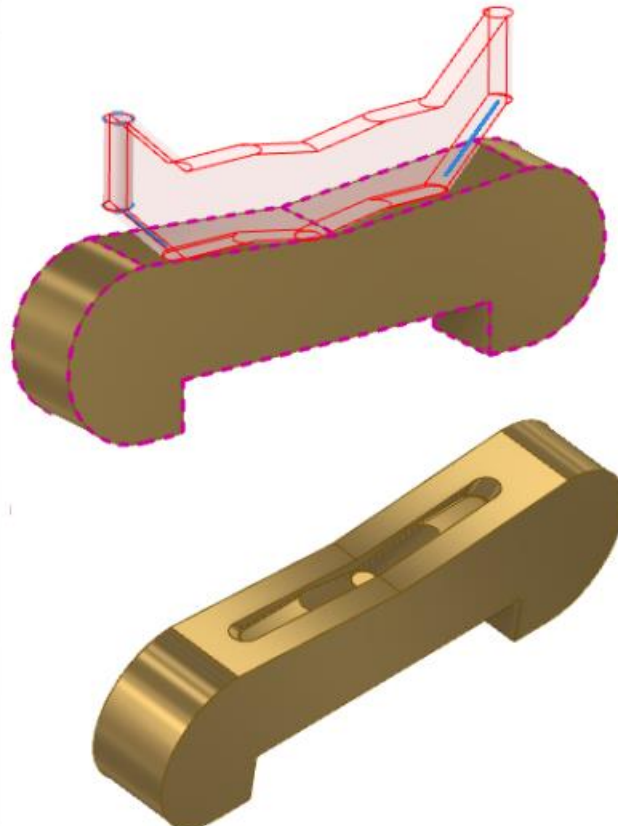
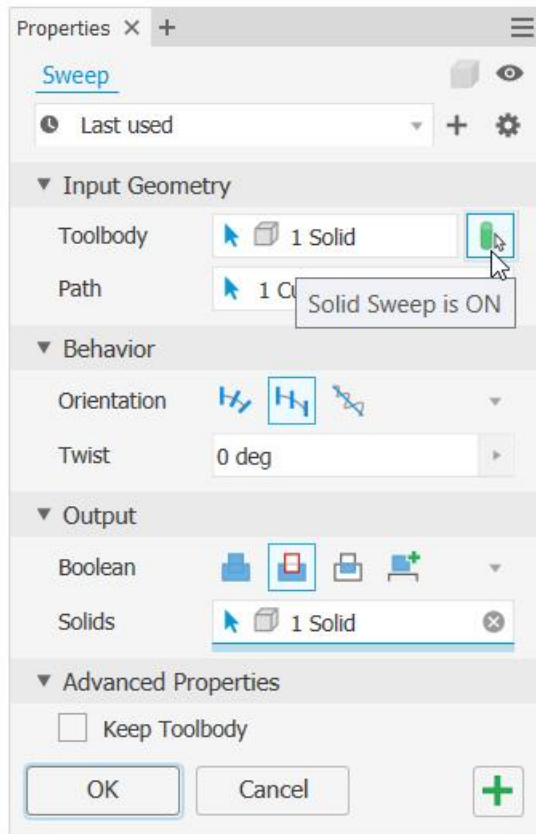

The next example shows the effect of using a 90-degree twist in an Aligned sweep to design a feed screw that rotates a bottle from horizontal to vertical.

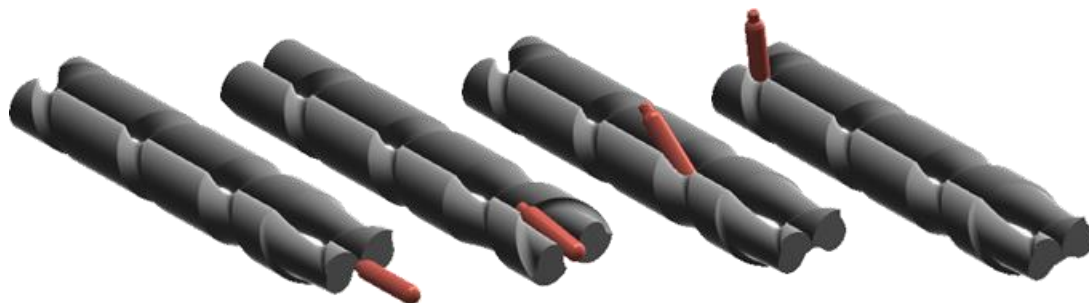

(Model credit: [Scott Moyse](#))

Relationships Enhancement

Sketch blocks consumed by features now display in the Relationships dialog box.

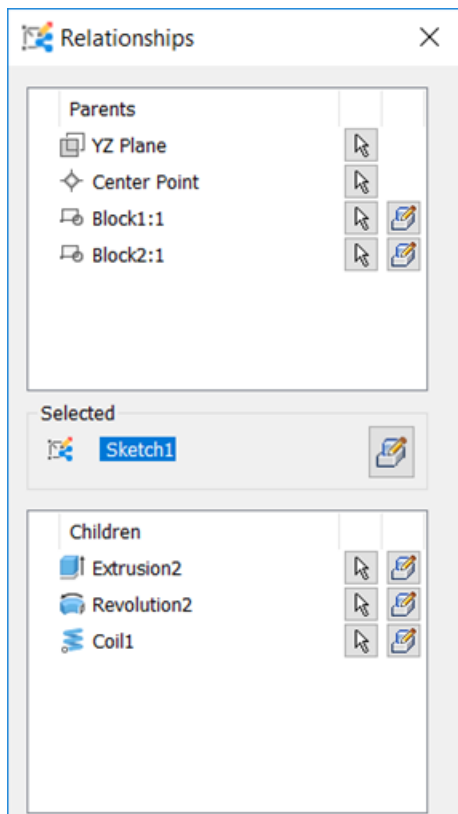

Support for Multiple Face Selection

You can now select multiple faces and add a thread to extruded cylindrical/conical faces that go through multiple parts together. Each face must be the same size, diameter, and contiguous to one another.

I [An Inventor® Ideas submission](#)

User Interface Enhancements

General enhancements to the Inventor user interface and graphics display.

User Interface Enhancements

A new User Interface theme is part of the enhancements for 2020. The Light Theme updates touch all aspects of the user interface, including color scheme, icons, display color or background, manipulators, and ground plane. Also, there are new graphic presets designed as alternatives for time spent adjusting display parameters.

Graphic Presets

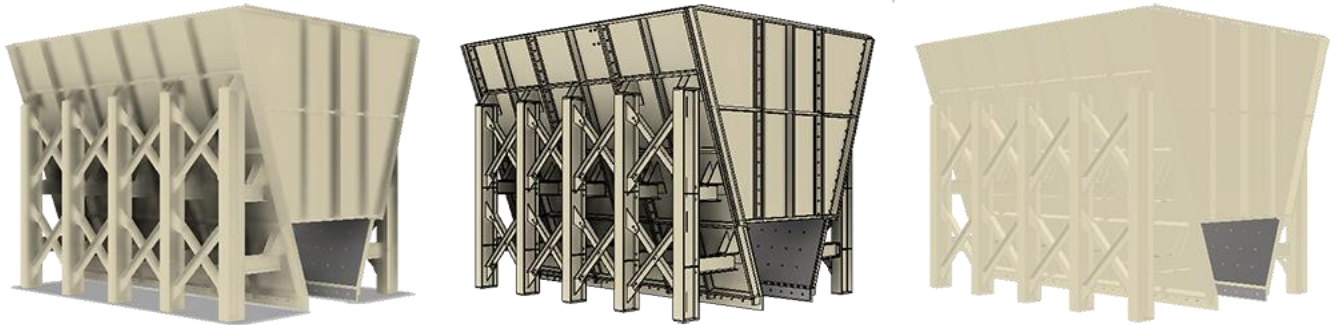

Three new Graphic Presets provide a look and feel for working with your designs.

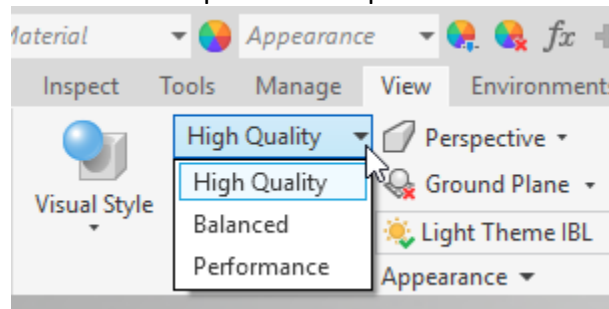

High Quality - places emphasis on providing pleasing visual results utilizing a new IBL lighting style **Light Theme IBL**, Realistic visual style, and shadows. Best used for high visual quality in product demos or final quality ray trace renders.

Balanced - places the emphasis on both visual display and performance. Balanced is the default setting for built-in part templates utilizing the new IBL lighting style **Light Theme IBL**, Shaded with edges visual style, and ambient shadows. Ideal for working with parts and small-to-modest sized assemblies.

Performance - places emphasis on performance over visual display. Performance is the default setting for built-in assembly templates utilizing a new lighting style **Light Theme**, Shaded visual style, and no shadows. Best used for working with medium-to-large assemblies.

Visual Refresh

Various parts of the Inventor user interface underwent a refresh to update their display.

New **Lighting Styles**: Light Theme and Light Theme IBL (default).

Icon Refresh - Inventor ribbon and browser icons are updated and refreshed to complement the light theme interface.

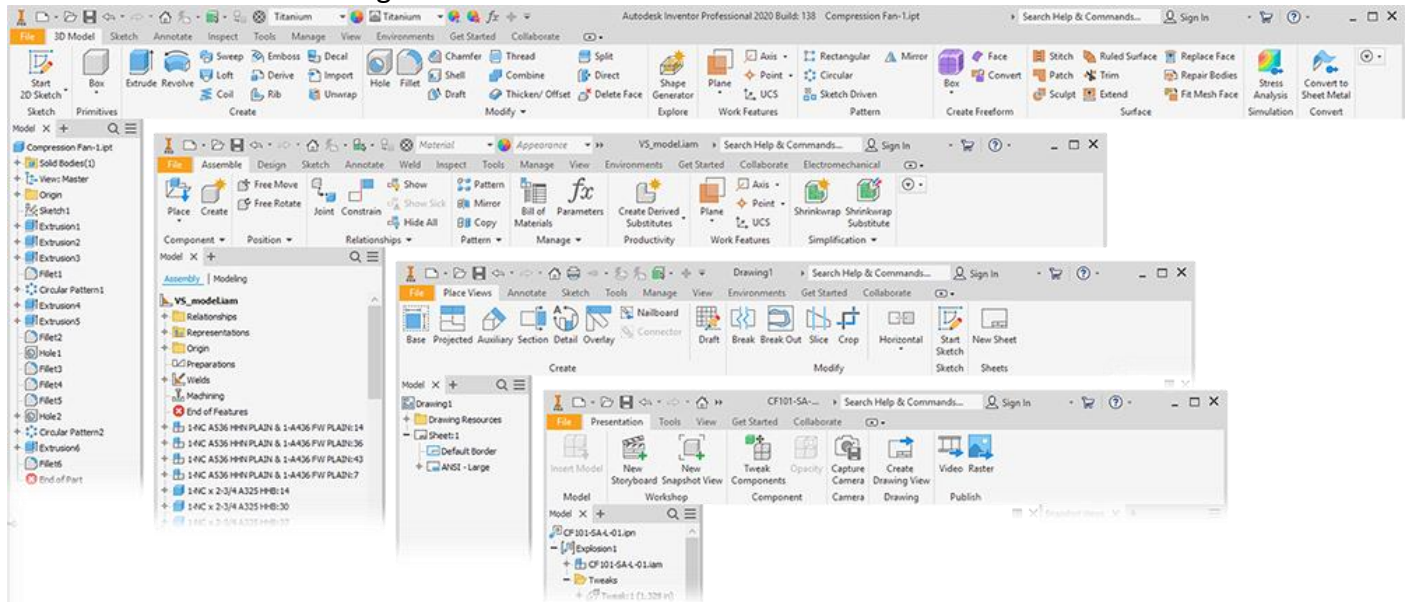

Feature Manipulators - updated colors that work with the light theme interface.

Thread texture - updated thread texture to provide better fidelity.

Ground Plane - updated to be compatible with the new color scheme. Added option to dynamically reduce the grid line count when zooming out. The count is restored gradually as you zoom in. The major axes are colored to match the Origin axes seen in the model triad in the lower left corner of the graphics display.

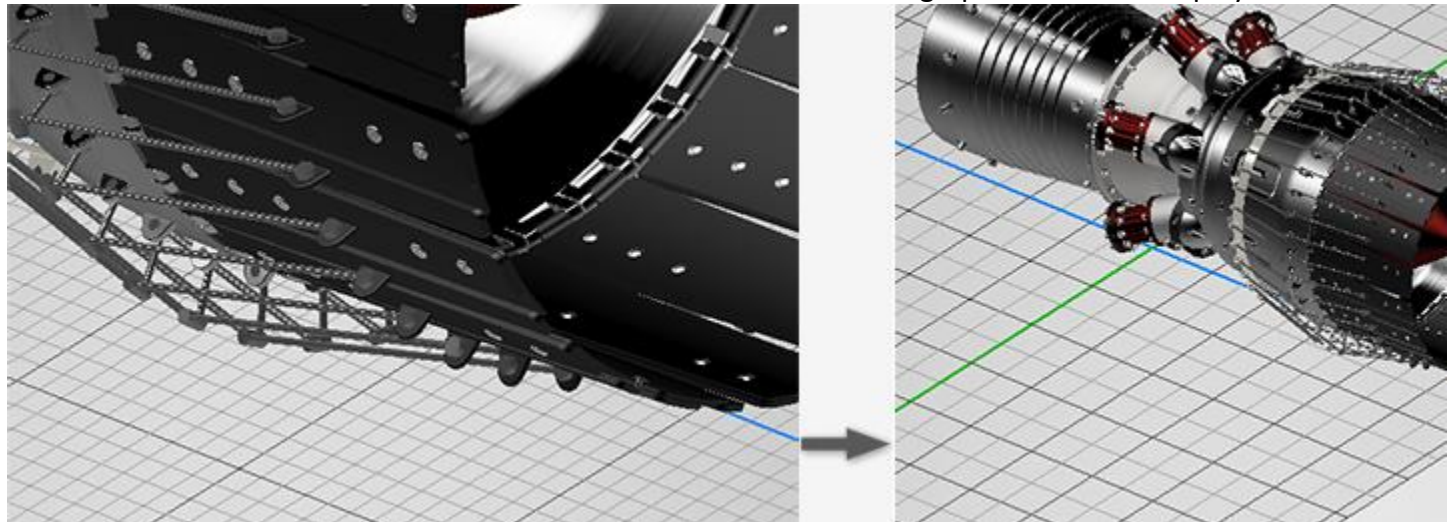

Property Panels

Property panel layout and buttons are enhanced.

The image shows a software property panel for a 'Hole' feature. The panel is titled 'Properties' and contains several sections: 'Input Geometry', 'Type', 'Behavior', and 'Advanced Properties'. Annotations highlight various UI improvements:

- Edit feature and sketch names as you create them:** Points to the breadcrumb 'Hole1 > Sketch3' at the top of the panel.
- Active context highlighted in blue and underlined:** Points to the 'Hole1' part of the breadcrumb.
- Improved tooltips:** Shows two tooltip examples. The first is for 'Hole1 > Sketch3' with 'No P' and 'Edit Name' buttons. The second is for 'Hole1 > Sketch3' with 'No Preset' and 'Edit Feature' buttons.
- Improved button hover state:** Points to an eye icon in the top right of the panel.
- Distinct visual cues to show:** Points to the '3 Selected' text in the 'Position' field.
- Section Labels are left aligned to improve readability:** Points to the 'Termination' and 'Direction' labels in the 'Behavior' section.
- Increased icon hit area for improved click ability and visibility:** Points to a large icon in the 'Direction' section.
- Field with focus has colored border:** Points to the '0.25 in' value field in the 'Behavior' section.
- Checkbox and label left aligned to improve visual connection, text is clickable:** Points to the 'iMate' and 'Extend Start' checkboxes in the 'Advanced Properties' section.
- Selector Style:** A dropdown menu is shown with options 'Icons' (checked) and 'Dropdown'. An annotation says 'Switch from to dropdown setting per sessions'.
- Apply and Create new:** Points to a green plus button at the bottom right.
- When panel is docked, the b remain close to the panel fi:** Points to a floating 'Apply' button with a green plus icon.
- Button color sync'd with HU:** Points to the floating 'Apply' button.

Feature naming during creation is an  [An Inventor® Ideas submission](#).

Application Options

The changes to Application Options are listed relative to dialog box tab.

Color Tab: New In-canvas Color Scheme: **Light Theme:**

Background Image: Light Blue Theme.png

Reflection Environment: studio_02.dds

Section Capping Plane Texture: Default - Gray

Various in-canvas color changes

Legacy styles are unchanged

UI Theme: Amber, displays legacy amber icons in the light theme interface. Check the box, save the change, and restart Inventor to see the icons.

Support for Threads in Assemblies

You can now create thread features in assemblies.

Access:

Assembly: 3D Model tab, Modify Assembly panel, Thread 

Weldment assembly: Weld tab, Preparation and Machining panel, Thread 

Support for Multiple Face Selection

You can now select multiple faces and add a thread to extruded cylindrical/conical faces that go through multiple parts together. Each face must be the same size, diameter, and contiguous to one another.

 [An Inventor® Ideas submission](#)

Content Center Enhancements

A plus sign no longer displays in front of a category that does not have a sub folder. You can now search using keywords such as, ANSI M8x13, and the related members display in the search results. In addition, Quick Search now supports 2 wildcard characters: The asterisk (*), which represents one or more characters, and the question mark (?), which represents a single character.

Inventor Read-only Mode

Inventor Read-only Mode allows you to access Inventor part (.ipt), assembly (.iam), drawing (.idw, dwg), and presentation (.ipn) files for viewing in the Inventor user interface without consuming a license.

Inventor Read-only mode is included as part of the Inventor installation. Anyone who does not have Inventor installed can use this mode by downloading the Inventor trial from www.autodesk.com/products/inventor/free-trial. Trial access to full Inventor capabilities is time bound. Inventor Read-only Mode does not expire.

Important: Although Inventor View no longer installs with Inventor, Inventor View continues install with Autodesk Vault and can also be downloaded as a standalone application from <https://www.autodesk.com/viewers/all-viewers>.

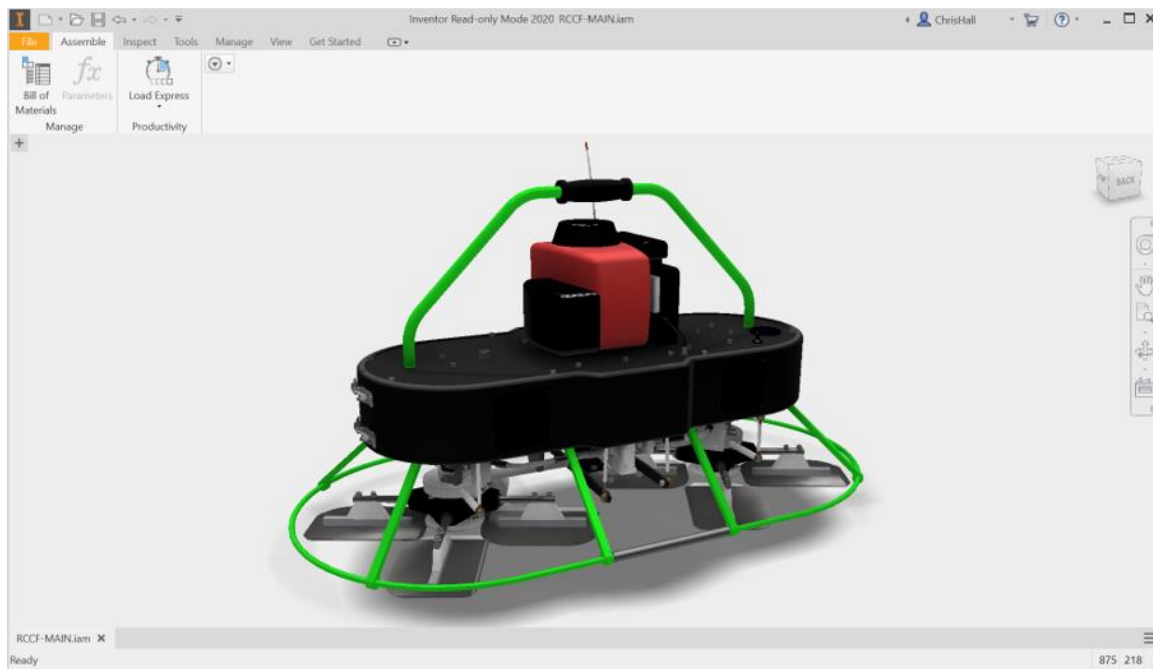

Performance & Productivity Enhancements

Significant performance improvements are seen in the following areas (Assembly-related improvements are not available in Inventor LT):

Assembly (not available in Inventor LT)

- Entering In-place edit is faster.
- Window selection, when using Component, Part, or Body selection filters, shows significant performance improvement.
- Pan, Zoom, and Rotate performance for multiple component selection sets are improved.
- Component pattern was redesigned to:
 - Improve performance in preview display and navigation.
 - Use the active view representation, not the master view representation.
 - Improve pattern compute performance.
 - Improve performance of patterning virtual components.
- Using the Visibility toggle, in the marking and context menus, is faster for deeper level components in large assemblies.
- Using Object Visibility to change the state of work features, 2D sketches, 3D sketches, and so on.

Express Mode

3D Section View performance is improved.

For large assemblies, Open or Close performance for the following commands is improved:

Environment	Command	
Assembly	Appearance Adjust Clear Material Hole	Chamfer Fillet Move Face Extrude
Assembly > Create 2D Sketch	Equation Curve Project DWG Geometry	
Assembly > Place DWG	DWG underlay Import DWG underlay Add Instance DWG Underlay Layer Visibility DWG Underlay Crop	
Assembly > in-place edit of Part	Extrude Thicken/Offset Revolve	Fillet Face Draft Direct Edit

Environment	Command	
	Hole Chamfer	Ruled Surface
Assembly in-place edit of Part > Create Freeform	Fit Mesh Face Box Face Symmetry Clear Symmetry Mirror Torus Sphere Quadball Plane	Cylinder Align Form Bridge Insert Point Edit Form Match Edge Merge Edges Thicken Unweld Edges Weld Vertices
Assembly in-place edit with Part > Import DWG	DWG underlay Import DWG underlay Translate DWG Underlay Redefine	DWG Underlay Crop DWG underlay Add Instance DWG Underlay Layer Visibility
Assembly in-place edit with Part > Create 3D Sketch	Equation Curve 3D Transform	
Assembly in-place edit with Part > Create 2D Sketch	Equation Curve Project DWG Geometry	

Tube & Pipe

Overall performance is improved.

Part

Feature pattern performance is improved for:

- Nested feature patterns.
- Identical feature patterns.
- Part files with imported DXF or DWG files open faster.

Drawing

- Improved view preview performance provides faster drawing workflows.
- Changing hidden line display of a part in an assembly view using the part browser context menu Hidden Lines option.
- Auxiliary view creation is faster, and is most noticeable when working with large assemblies.
- Drawing Section View performance is improved.

AnyCAD

Import and edit performance of Reference AnyCAD assembly files is improved.

Import dialog box displays faster.

File Format	Displaying Import dialog box	Editing and Finishing
Rhino	Improved	No change
JT	Improved	No change
ParaSolid	Improved	No change
Catia V4	Improved	No change
Catia V5	Improved	Improved
STEP	Improved	Improved
NX	Improved	Improved
IGES	Improved	No change
SolidEdge	No change	Improved
SolidWorks	No change	Improved
ProE	No change	Improved
Creo	No change	Improved
Fusion	No change	No change

Mesh Import

The mesh import performance is improved.

Productivity

Added support for 2D sketches, 3D sketches, and work features to enable skeletal modeling workflows in Express Mode.

Multimonitor Enhancements

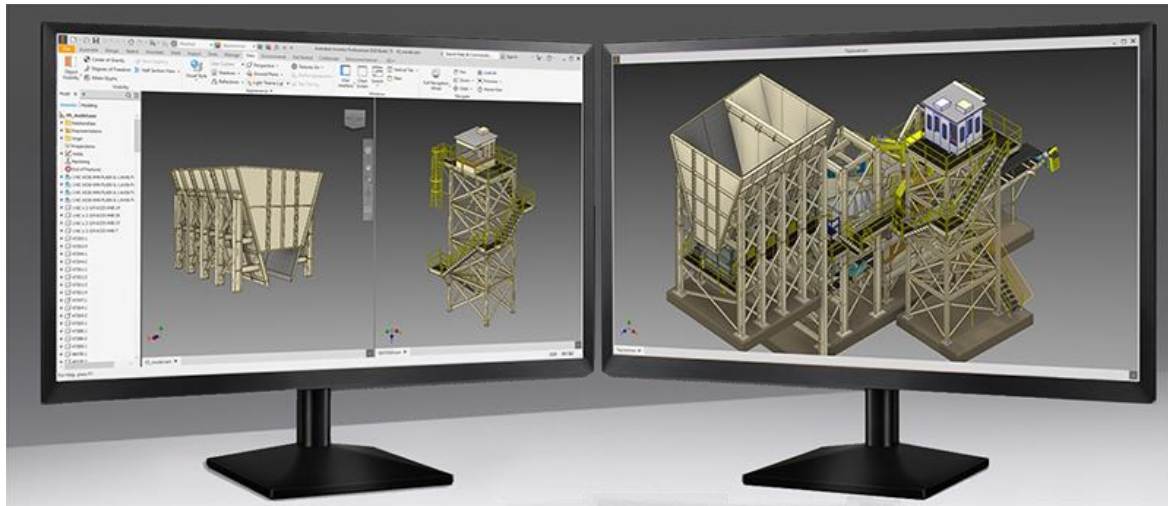

You can use a single Inventor session in multiple windows and with multiple monitors. The new window management commands allow you to:

- Drag document tabs outside the main inventor window onto another monitor. Not available when a command is active.
- Arrange documents side by side, top to bottom in various configurations.
- Window tile toggles are moved to the advanced drop-down menu at the far right of the document tab bar.
- Clean Screen also hides the document tab. Propose: "If you want to work without the browser, document tab, and ribbon and maximize your workspace, use the Clean Screen toggle. "
- Model Browser and dockable windows can be docked to the primary or secondary window frames. The Ribbon docks only to the primary window frame.

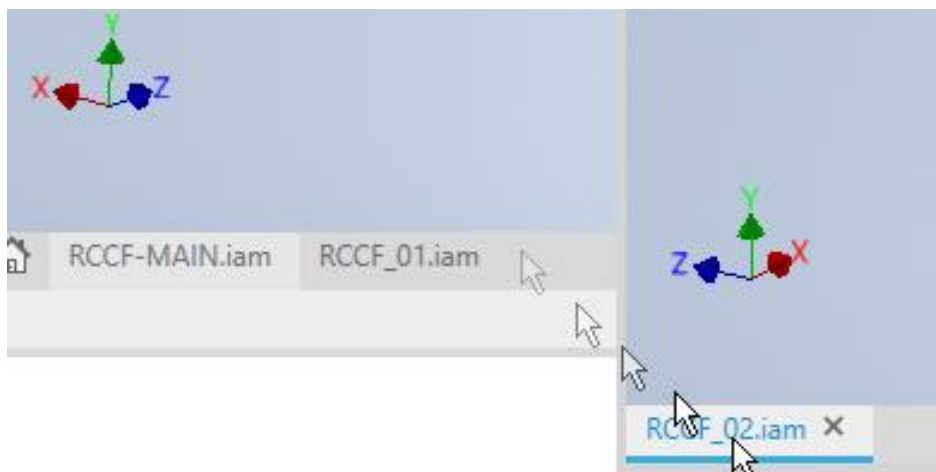

Migration Enhancements

When installing a new version of Inventor, you can migrate certain settings from a previous release. You select which group of settings to migrate.

New groups of command settings can be migrated between releases.

Settings: Command Settings - select this option to migrate property panel Advanced Settings options, No Preset setting, and Last used settings for property panel-based commands.

Content:Presets - select this option to part feature custom presets for property panel-based commands. Property panel-based commands include Hole, Extrude, Revolve, Sweep, Thread. Also, Frame Generator commands such as End Cap, Miter, Notch, and Lengthen/Shorten. Also stored are drawing symbol command presets for End Fill, Welding Symbols, Surface Texture, and Feature Control Frames.

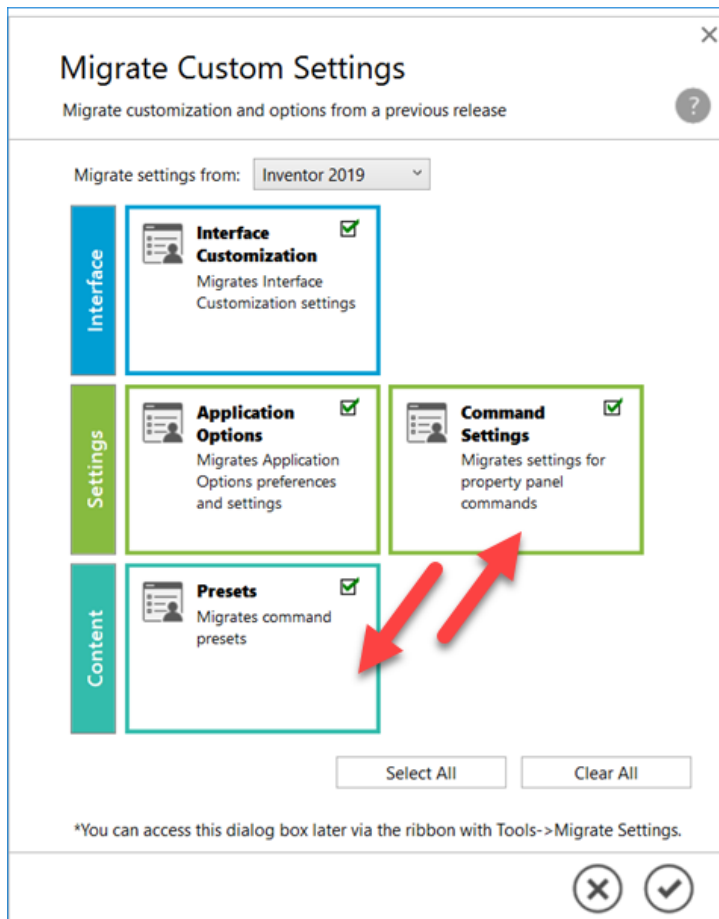

Translation Enhancements

See the tables below for translators with newly supported versions.

Import Enhancements

Translator	Support for the following version
CATIA V5	V5-6R2018
JT	10.2
Parasolid	31.0
Rhino	6.0
Solidworks	2001 Plus - 2019

Export Enhancements

Translator	Support for the following version
CATIA V5	V5-6R2018
JT	10.2
Parasolid	31.0
Rhino	6.0

Sketch Enhancements

Several sketch behaviors have been improved to enhance productivity.

Loop and Region Detection

Identifying and selecting loops and regions is enhanced. As you hover or move the cursor over sketch loops or enclosed regions these items highlight. This behavior also applies to sketch blocks. As in previous releases, use Ctrl+click to add or remove items from the selection set. During the hover state, the cursor and status bar notifications update to show the action that results with a click.